

NINJA®

OWNER'S GUIDE

BL492UK



 www.ninjakitchen.eu

 0800 862 0453

Welcome to the Ninja® Compact Blender Duo all-purpose, customisable, everyday kitchen assistant. The Ninja Compact Blender Duo features pre-programmed settings that take the guesswork out of drink and meal making. These programs are timed to deliver consistent, delicious results that finish on their own so all you have to do is press a button and enjoy.

Select accessories are included. Additional accessories are available for purchase at www.ninjakitchen.eu. For a list of what is included with this model, refer to the top of the box or online.

If you should have a question about your Ninja Compact Blender Duo, please call the Ninja Customer service line at 0800 862 0453.

THANK YOU!

REGISTER YOUR PURCHASE:

 www.ninjakitchen.eu
 0800 862 0453

RECORD THIS INFORMATION:

Model Number: _____
 Date of Purchase (Keep receipt): _____

THIS BOOK COVERS MODEL NUMBER:
 BL492UK 30

TECHNICAL SPECIFICATIONS:

Voltage: 220-240V~, 50/60Hz
Power: 1200W
Pitcher Capacity: 2.1 L
Max Liquid Capacity: 2.0 L
Nutri Ninja Cup Capacity: 650ml
 900ml



This appliance complies with the WEEE-Directive 2012/19/EU on the disposal of electrical and electronic equipment (WEEE).

This marking indicates that this product should not be disposed with other household wastes throughout the EU. To prevent possible harm to the environment or human health from uncontrolled waste disposal, recycle it responsibly to promote the sustainable reuse of material sources. To return your used device, please use the return and collection systems or contact the retailer where this product was purchased. They can take this product for environmental safe recycling.

This appliance complies with the European directives for electromagnetic compatibility (EMC) 2014/30/EU and its revisions, as well as Low Voltage Directive (LVD) 2014/35/EU and its revisions.

Guarantee: This product is unconditionally guaranteed for one year against all defects of workmanship and materials. This guarantee does not affect your statutory rights. If this product proves unsatisfactory please contact our customer service department on freephone 0800 862 0453 or by e-mail ukservice@euro-pro.com.



IMPORTANT SAFETY INSTRUCTIONS





Read all instructions before using your Ninja® product. When using an electrical appliance, basic safety precautions should always be observed, including the following:



IMPORTANT: This appliance is not intended for use by persons with reduced physical, sensory or mental capabilities, or lack of experience and knowledge, unless they have been given supervision or instruction concerning use of the appliance by a person responsible for their safety.

Children shall not use or play with this appliance. Close supervision is necessary to keep appliance and cord out of reach of children during use.

 **WARNING**

TO REDUCE THE RISK OF FIRE, ELECTRIC SHOCK OR INJURY:

- 1  **WARNING:** Remove utensils prior to processing. Failure to remove may cause the jar to be damaged or to shatter which may cause personal injury.
- 2  **WARNING:** The blade assemblies are sharp, not locked in place and removable, handle with care. When handling the blade assemblies, always hold by the shaft. Failure to do so will result in a risk of laceration.
- 3  **WARNING:** Stacked Blade Assembly is sharp and not locked in place. If using the pour spout, ensure the lid is fully locked onto the pitcher. If pouring with the lid removed, carefully remove the Stacked Blade Assembly first, holding it by the shaft. Failure to do so will result in a risk of laceration.
- 4  **CAUTION:** Do not blend hot liquids, doing so may cause excessive pressure build-up, resulting in risk of the user being burned.
- 5  **CAUTION:** We do not recommend grinding in any of our Nutri Ninja® cups.

- 6  **CAUTION:** Remove the Pro Extractor Blades™ Assembly from the Nutri Ninja cup upon completion of blending. Do not store ingredients before or after blending them in the cup or jar with the blade assembly attached. Some foods may contain active ingredients or release gases that will expand if left in a sealed container, resulting in excessive pressure buildup that can pose a risk of injury. For ingredient storage in the cup, use Spout lid to cover.
- 7  **WARNING:** Extension cords are not recommended for use with this product.
- 8  **CAUTION:** In order to avoid a hazard due to inadvertent resetting of the thermal cut-out, this appliance must not be supplied through an external switching device, such as a timer, or connected to a circuit that is regularly switched on and off by the utility.
- 9 **IMPORTANT:** Attachments are not interchangeable.
- 10 **IMPORTANT:** Never add ingredients to the pitcher before inserting the blade assembly first.
- 11 **IMPORTANT:** Do not attempt to operate the pitcher without the lid on.
- 12 **IMPORTANT:** Never run the appliance empty.
- 13 **IMPORTANT:** Make sure that the motor base is plugged in for use.
- 14 **IMPORTANT:** Make sure that the motor base is unplugged when not in use.
- 15 To protect against electrical shock, do not submerge the appliance or allow the power cord to come into contact with water or any other liquid.
- 16 DO NOT allow the appliance to be used by children. Close attention is necessary when used near children. This is not a toy.
- 17 Never leave the appliance unattended when in use.
- 18 Turn the appliance off and remove the power cord from the electrical outlet when not in use, before assembling or disassembling parts, accessing parts that move while in use, and before cleaning. To unplug, grasp the plug and pull from the electrical outlet. Never pull from the power cord.

SAVE THESE INSTRUCTIONS

IMPORTANT SAFETY INSTRUCTIONS

- 19** DO NOT abuse the power cord. Never carry the appliance by the power cord or yank it to disconnect from the electrical outlet; to unplug, grasp the plug, not the cord.
- 20** DO NOT use with damaged cord or plug.
- 21** DO NOT USE if the appliance is not working, after it has been dropped, dropped into water, damaged, or left outdoors.
- 22** NO SERVICEABLE PARTS. Incorrect re-assembly or repair can cause a risk of electrical shock or injury to persons when the appliance is used.
- 23** DO NOT let the power cord hang over the edge of a table or counter or touch hot surfaces such as the stove.
- 24** Always use the appliance on a dry, level surface. Make sure the suction cup feet are wiped clean and no crumbs or residue are on the bottom of them.
- 25** Keep hands, hair, clothing, and utensils out of container while processing to reduce the risk of severe injury to persons or damage to the appliance. A scraper may be used ONLY when the appliance is not running.
- 26** Avoid contact with moving parts.
- 27** DO NOT attempt to sharpen blade assemblies.
- 28** DO NOT use the appliance if the blade assembly is bent or damaged.
- 29** To reduce risk of injury, never place the blade assembly on the motor base without the proper container.
- 30** DO NOT operate this appliance on or near any hot surfaces (such as on a gas or electric burner or in a heated oven).
- 31** The use of attachments or accessories (including canning jars), that are not recommended or sold by the manufacturer may cause fire, electric shock, or personal injury.
- 32** DO NOT remove the container (cup, pitcher, etc.) from the motor base while the appliance is running.
- 33** To reduce the risk of injury, NEVER operate the appliance without the blade assembly installed in a container. DO NOT try to defeat the interlock mechanism; make sure the blade assembly is properly installed before operating the appliance.
- 34** DO NOT expose containers (cups, pitcher, etc.) to extreme temperature changes.
- 35** DO NOT overfill.
- 36** Max ON time is 60 seconds under 1200W load. If the appliance overheats, a thermal switch will become activated and shut off the motor. To reset, unplug the appliance and let it cool down for approximately 30 minutes before using again.
- 37** To reduce the risk of burns, always allow the appliance to cool before taking off parts and before cleaning.
- 38** To avoid injury, never attempt to place the Pro Extractor Blades™ Assembly onto the motor base without first assembling the blade assembly to the Nutri Ninja® Cup.
- 39** THIS PRODUCT IS INTENDED FOR HOUSEHOLD USE ONLY. Do not use this appliance for anything other than its intended use. Do not use outdoors.
- 40** Appliance accessories are NOT intended to be used in the microwave. DO NOT place the containers (cups, processor bowls, lids, etc.) in the microwave as it may result in damage to the accessories.

FEATURES:

- Nutrient & Vitamin Extraction†
 - 1200 Watt Motor
 - User Interface:
 - POWER (⏻)**
Press this button at any time if you wish to pause or end the program.
 - SMOOTH BOOST™**
SMOOTH BOOST YES/NO is a special feature available when using the Auto-iQ® EXTRACT and Auto-iQ BLEND. This setting can be used to control the consistency of your beverage recipes. Select SMOOTH BOOST YES when smoother, creamier results are desired. This is the default program for both Auto-iQ EXTRACT and Auto-iQ BLEND programs. Select SMOOTH BOOST NO when more of a textured consistency is desired.
 - PULSE**
Offers greater control to help prevent over-processing or over-blending. Simply hold down the button and our blades will run at a high speed for a quick burst of power to break through ice or chop vegetables.
 - HIGH**
HIGH is a manual setting that runs for 60 seconds and then automatically shuts off. Use for dips, sauces, or frozen smoothies if you want to control the consistency.
 - LOW**
LOW is a manual setting that runs for 30 seconds and will automatically shut off. On this setting, blades rotate at a slower speed, allowing heavy recipes like doughs to be mixed.
 - AUTO-IQ EXTRACT†**
EXTRACT should be used when blending hard, leafy, or fibrous whole fruits and vegetables, including apples, kale, and celery. This optimized program allows you to blend fresh items with their skins, seeds, and stems into nutrient extractions. Before using EXTRACT, select Smooth Boost YES or NO depending on your desired consistency.
 - AUTO-IQ BLEND**
BLEND can be used to make a range of beverages that do not include hard or fibrous fresh ingredients, such as milkshakes, protein smoothies, soft fresh-fruit smoothies, and frozen cocktails. Before using BLEND, select SMOOTH BOOST YES or NO depending on your desired consistency.
 - Spout lids for drinks on the go.
 - Nutri Ninja® Cups and spout lids, BPA free, and dishwasher safe.
 - 2.1 L Pitcher (max liquid capacity: 2 L) & lid, BPA free, and dishwasher safe.
 - Cord Wrap located on back of the motor base.
 - Ice to Snow**
Crushing Ice to Snow is easy – take ice cubes directly from your freezer, and put in a dry Ninja® Cup – use the pulse feature in short quick bursts until it's a snow-like consistency.
- †Extract a drink containing vitamins and nutrients from fruits and vegetables.

SAVE THESE INSTRUCTIONS

Nutri Ninja® Cups

▲ **CAUTION:** Do not blend hot liquids.



650 ml 900 ml

Spout Lid

NOTE: Spout lid and Pro Extractor Blades™ Assembly can be used with all Ninja® Cups.



Pro Extractor Blades™ Assembly



Stacked Blade Assembly (pitcher)

Pitcher/Lid

Max liquid capacity:
2 L



2.1 L



Motor Base



ACCESSORIES

Select accessories are included. Others are available for purchase at www.ninjakitchen.eu or by calling 0800 862 0453.

ASSEMBLY AND USE FOR THE NUTRI NINJA® CUPS



fig. 1

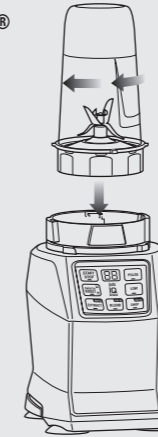

fig. 2



fig. 3



fig. 4

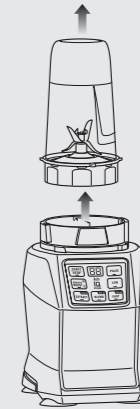

fig. 5

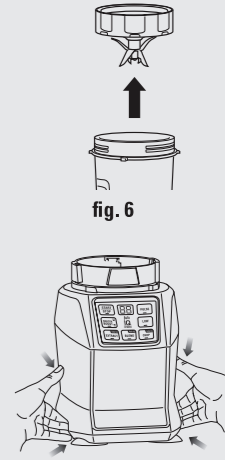

fig. 6

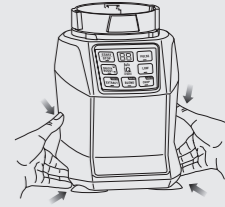

fig. 7

ASSEMBLY

USE

REMOVAL

For best results, follow the recipe/ingredient loading instructions found in your Inspiration Guide.

▲ **WARNING:** Handle the Pro Extractor Blades™ Assembly with care, as the blades are sharp.

▲ **WARNING:** Remove utensils prior to processing. Failure to remove may cause the Nutri Ninja cup to be damaged or to shatter, which may cause personal injury.

▲ **WARNING:** Never leave the appliance unattended while in use.

▲ **CAUTION:** Do not blend hot liquids, doing so may cause excessive pressure buildup, resulting in risk of the user being burned.

▲ **CAUTION:** Remove the Pro Extractor Blades™ Assembly from the Nutri Ninja cup upon completion of blending. Do not store ingredients before or after blending them in the cup or jar with the blade assembly attached. Some foods may contain active ingredients or release gases that will expand if left in a sealed container, resulting in excessive pressure buildup that can pose a risk of injury. For ingredient storage in the cup, use spout lid to cover.

NOTE: Ninja® Auto-iQ® Technology can sense which jar is on the motor base. The function lights will illuminate depending on which container is placed on the motor base.

IMPORTANT: When processing soft dry ingredients such as day-old bread or cheese use quick, short 1 second pulses. Do not overfill to avoid overheating the appliance. Allow the appliance to cool after each use.

- 1 Review warning and caution statements above before proceeding to number 2.
- 2 Place the motor base on a clean, dry, level surface such as a counter or tabletop. Press down on the motor base to make sure that the suction cups adhere to the counter or tabletop.
- 3 Add ingredients to the Nutri Ninja cup.
NOTE: Do not overfill! To avoid spilling, do not add ingredients past the "MAX" fill line.
- 4 Place the Pro Extractor Blades Assembly onto the cup and tightly screw it on clockwise until you have a good seal. (Fig. 1)
- 5 Turn the Nutri Ninja cup upside down and place it onto the motor base, aligning the tabs on the

cup with the motor base. Rotate the Nutri Ninja cup clockwise until it locks in place, you will hear a click when the lock is engaged. (Fig. 2)

- 6 Once the cup is engaged, the programs available for that attachment will illuminate. Select the program desired based on your recipe. (Fig. 3)
- 7 To pause the appliance, press the selected speed or Auto-iQ program a second time. When the program is paused, the light on the program button will flash until you press it again to resume the rest of the program.
- 8 Once you have reached your desired consistency, press the **POWER** button to turn the program off. Turn the Nutri Ninja cup anticlockwise (Fig. 4) and pull straight up to remove. (Fig. 5)
- 9 Turn the cup upright and remove the Pro Extractor Blades Assembly by twisting the Pro Extractor Blades Assembly anticlockwise.

- 10 Do not store blended contents in the Nutri Ninja cup with the Pro Extractor Blades Assembly attached. (Fig. 6)
- 11 Place the spout lid onto the Nutri Ninja cup, twist to seal and enjoy!
- 12 Make sure that the motor base is unplugged when not in use.
- 13 For storage in the cup, use spout lid to cover.
- 14 To release the motor base from the counter or tabletop, place your fingers under the sides of the black paddles on the sides of the base and lift up to release suction cup feet. (Fig. 7)
- 15 Be sure to store the Pro Extractor Blades Assembly attached to an empty cup when not in use.

**ASSEMBLY AND USE
FOR THE 2.1 L PITCHER**

(Max Liquid Capacity: 2 L)

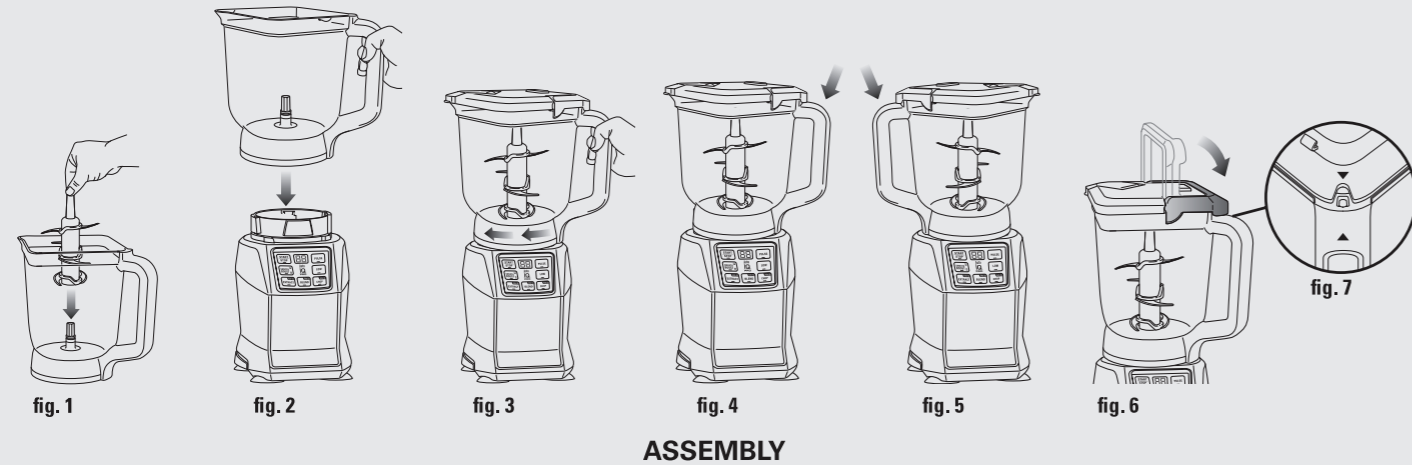

ASSEMBLY

For best results, follow the recipe/ingredient loading instructions found in your Inspiration Guide.

- ⚠ **WARNING:** Handle the Stacked Blade Assembly with care, as the blades are sharp.
 - ⚠ **WARNING:** Remove utensils prior to processing. Failure to remove may cause the pitcher to be damaged or to shatter, which may cause personal injury.
 - ⚠ **WARNING:** Never leave the appliance unattended while in use.
 - ⚠ **CAUTION:** Do not blend hot liquids, doing so may cause excessive pressure buildup, resulting in risk of the user being burned.
- IMPORTANT:** Make sure that the motor base is plugged in for use.

NOTE: Ninja® Auto-iQ® Technology can sense which jar is on the motor base. The function lights will illuminate depending on which container is placed on the motor base.

⚠ **CAUTION:** The Stacked Blade Assembly is sharp and not locked in place. If using the pour spout, ensure the lid is fully locked onto the blender pitcher.

⚠ **CAUTION:** The Stacked Blade Assembly is sharp and not locked in place. If pouring with the lid removed, always remove the Stacked Blade Assembly first.

- 1 Review warning and caution statements above before proceeding to number 2.
- 2 Place the motor base on a clean, dry, level surface such as a counter or tabletop. Press down on the motor base to make sure the suction cups adhere to the counter or tabletop.
- 3 Holding the Stacked Blade Assembly by the top of the shaft, place it onto the drive gear inside the pitcher. Ensure that the Stacked Blade Assembly is seated properly and is standing upright. (Fig. 1)
NOTE: The Stacked Blade Assembly will fit loosely on the drive gear.
- 4 Align and lower the pitcher onto the motor base. (Fig. 2) Handle should be aligned slightly to the right of the "LOCK" symbol on the motor base.
- 5 Rotate the pitcher clockwise until it locks in place, you will hear a click when the lock is engaged. (Fig. 3)
NOTE: The pitcher can be placed on the motor base two ways; the handle can be on the front right corner or the front left corner. (Fig. 4, Fig. 5)
- 6 Add the ingredients to the pitcher, making sure that they do not exceed the highest measured marking line on the side of the pitcher.
NOTE: When blending any kind of liquids, such as mixtures of any drinks or smoothies, do not exceed the "MAX LIQUID" mark (2 L) on the pitcher.

NOTE: If you need to add additional ingredients while the appliance is processing, turn the unit off, open the pour spout cap, and pour the ingredients in through the opening.

- 7 Holding the lid by the handle in the upright position, place it on top of the pitcher aligning the triangle located on the lid with the triangle located on the pitcher's handle. (Fig. 6) Press the handle down until you hear a click. The triangles on the lid and the blender handle **MUST** be aligned in order for the blender to turn on. (Fig. 7)
- 8 Plug the power cord into the electrical outlet. The function lights will illuminate.

**ASSEMBLY AND USE
FOR THE 2.1 L PITCHER**

(Max Liquid Capacity: 2 L)

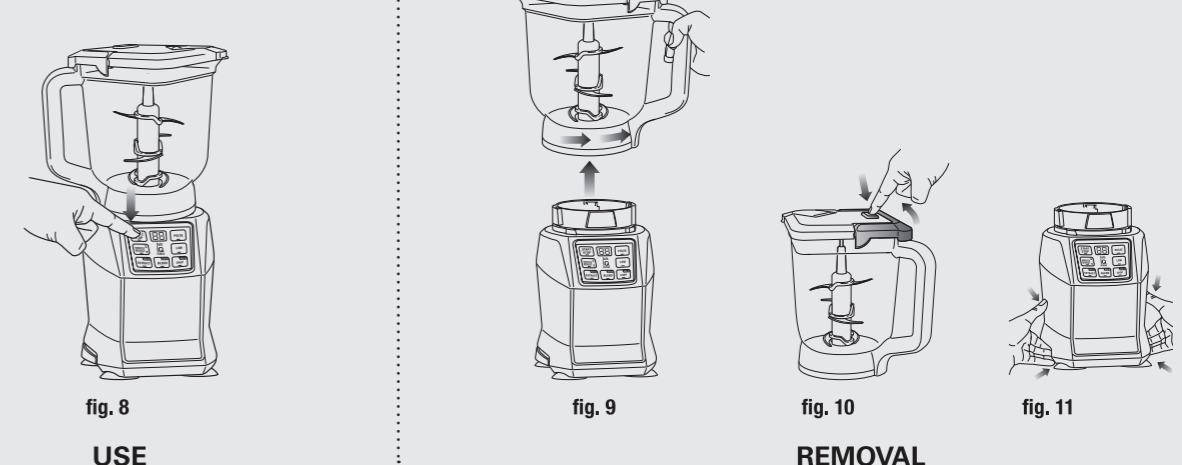

USE

REMOVAL

NOTE: Ninja® Auto-iQ® Technology can sense which jar is on the motor base. The function lights will illuminate depending on which container is placed on the motor base.

- 9 Review warning and caution statements at the top of page 8 before proceeding to number 10.
- 10 Once the pitcher is engaged, the programs available for that attachment will illuminate. Select the program desired based on your recipe. (Fig. 8) The Auto-iQ program will stop the appliance automatically at the end of the program.
- 11 To pause the appliance, press the selected speed or Auto-iQ program a second time. When the program is paused, the light on the program button will flash until you press it again to resume the rest of the program.
NOTE: Pulse ingredients for even Oping by holding the PULSE button until your desired consistency is reached.

- 12 When you have reached your desired consistency, stop the appliance by pressing the **POWER** button and wait for the Stacked Blade Assembly to stop turning.
- 13 Turn the pitcher anticlockwise to remove and then lift off the base. (Fig. 9)
CAUTION: Never insert your hands in the pitcher as the blades are sharp. Always use a spatula to dislodge food that has stuck to the sides of the pitcher.
- 14 Open the pour spout cap and use the spout to empty liquid contents. (Fig. 10)

- 15 For thicker consistencies, first remove the lid by pressing the release button and pulling the lid handle up to a 90 degree angle to lift lid off the pitcher. Then, carefully remove the Stacked Blade Assembly by the top of the shaft. Place Stacked Blade Assembly away from the work area to avoid accidental contact. Finally, empty contents from the pitcher.
- 16 Make sure that the motor base is unplugged when not in use.
- 17 To release the motor base from the counter or tabletop, place your fingers under the sides of the black paddles on the sides of the base and lift up to release suction cup feet. (Fig. 11)

CARE &
MAINTENANCE

CLEANING:

⚠ CAUTION: Make sure that the motor base is unplugged from the power source before inserting or removing any attachment and before cleaning.

⚠ CAUTION: DO NOT immerse the motor base into water or any other liquid.

- 1 Separate/remove all parts from each other.
- 2 Hand Washing: Wash the containers, lids, blade assemblies and attachments in warm, soapy water. When washing the blade assemblies, use a dish-washing utensil with a handle to avoid direct hand contact with blades. Handle blade assemblies with care to avoid contact with sharp edges. Rinse and air dry thoroughly.

Dishwasher: The containers, lids, blade assemblies and attachments are all dishwasher safe. The lids and blade assemblies are top rack dishwasher safe. Ensure that the Blade Assemblies are removed from the containers before placing in the dishwasher.

⚠ WARNING: Handle the Blade Assemblies with care when washing, as the blades are sharp. Contact with the blades' edges can result in laceration.

- 3 Wipe the motor base clean with a damp cloth.

Please call customer service if any servicing needs to be performed on the appliance at 0800 862 0453.

STORING:

- 1 Store the Ninja® Compact Blender Duo upright with the blade assembly inside the corresponding container with the lid secured on top. Do not place anything on top. Store the rest of the attachments in a safe place where they will not be damaged and won't cause harm. Loosely wrap the power cord around the motor base.

NOTE: Do not store blended or unblended ingredients in the Nutri Ninja cup with the blade assembly attached.

RESETTING THE MOTOR THERMOSTAT:

The Ninja Compact Blender Duo features a unique safety system which prevents damage to the unit's motor and drive system should you inadvertently overload your appliance. If the appliance is being overloaded, the motor will stop. Allow the appliance to cool for approximately 15 minutes. To reset the appliance, follow the resetting procedure below:

- 1 Unplug the appliance from the electrical outlet.
- 2 Remove and empty the container and ensure that no food is jamming the blade assembly.
- 3 Allow the appliance to cool for approximately 15 minutes.
- 4 Re-install the container onto the base and re-plug the appliance into the electrical outlet.
- 5 Proceed with using the appliance as before while making sure not to exceed the maximum recommended capacities.

TROUBLE-
SHOOTING
GUIDE

Unit doesn't turn on:

- Make sure the unit is plugged in and the **POWER** button is pressed.
- Insert and rotate the container or accessory clockwise in the base until it clicks into place. Display should illuminate.

Unit doesn't turn off:

- Remove cup from base by rotating cup anticlockwise and lifting out. Display should turn off. Unplug the power cord from the outlet.

Lid/blade assembly hard to assemble:

- Set the cup on a level surface. Place the lid or blade assembly on the top of the cup and align the threads so that the lid/blades sit flat on the cup. Twist clockwise so that the lid/blades evenly align to the cup until you have a tight seal.

Doesn't mix well, food gets stuck:

- Using the Auto-iQ programs is the easiest way to achieve great results. The pulses and pauses allow the food to settle towards the blade. If food is routinely getting stuck adding some liquid will usually help.
- When packing the cups, start with fresh items, then add liquids, then powders/dry ingredients, and finally frozen items or ice.

Unit moves on the counter while blending:

- Make sure the surface, as well as the feet of the unit, are clean and dry.

Unit is difficult to remove from the counter for storage:

- To release the motor base from the counter or tabletop, place your fingers under the sides of the black paddles on the sides of the motor base and lift up to release suction cup feet.

NINJA®

Euro-Pro Europe Limited
Century Way
Thorpe Park
Leeds
LS15 8ZB, UK
0800 862 0453



BL492UK_30_250220_New address

© 2016 Euro-Pro Europe Limited

Illustrations may differ from actual product. We are constantly striving to improve our products, therefore the specifications contained herein are subject to change without notice.

Printed in China

Auto-iQ, Nutri-Ninja and Ninja are registered trademarks of Euro-Pro Europe Limited.
Pro Extractor Blades and Smooth Boost are trademarks of Euro-Pro Europe Limited.



www.ninjakitchen.eu



0800 862 0453