

# NINJA®

## COFFEE BAR®

CF060UK

OWNER'S GUIDE



[www.ninjacoffee.eu](http://www.ninjacoffee.eu)

FREE PHONE 0800 862 0453

# IMPORTANT SAFEGUARDS

## For Household Use Only

### READ ALL INSTRUCTIONS BEFORE USING YOUR NINJA COFFEE BAR®.

#### Safety Signal Words

This manual and the safety labels attached to this appliance utilise signal words that signify safety hazards with different levels of severity.

Below are the words used and the definitions for these words:

- **WARNING** indicates a hazardous situation which, if not avoided, could result in death or serious injury.
- **CAUTION** indicates a hazardous situation which, if not avoided, could result in minor or moderate injury.
- **NOTICE** is used to address practices not related to physical injury.

The words “**WARNING**” and “**CAUTION**” are preceded by a triangle signifying that these are safety related.

The terms “**IMPORTANT**” and “**NOTE**” are also used to describe good ideas for better and more efficient equipment use.

**IMPORTANT:** This appliance is not intended for use by persons with reduced physical, sensory or mental capabilities, or lack of experience and knowledge, unless they have been given supervision or instruction concerning use of the appliance by a person responsible for their safety.

Children shall not use or play with this appliance. Close supervision is necessary to keep appliance and cord out of reach of children during use.

### **WARNING:**

To reduce the risk of fire, electric shock, serious injury, death or damage when using this appliance, follow these basic safety precautions.

#### General Precautions

- 1 Do not allow the appliance to be used by children. Close attention is necessary when used near children. This is not a toy.
- 2 To protect against electrical shock, do not submerge the appliance or allow the power cord to come into contact with water or any other liquid.

**NO SERVICEABLE PARTS.** Incorrect reassembly or repair can cause a risk of electrical shock or injury to persons when the appliance is used. Contact Customer Service or Service Center for the repair or replacement under the warranty agreement.

- 3 Surfaces are liable to get hot during use. Allow the appliance to cool before taking off parts and before cleaning.
- 4 Do not abuse the power cord. Never carry the appliance by the power cord or yank it to disconnect from electrical outlet; instead grasp the plug and pull to disconnect.
- 5 Do not operate any appliance with a damaged cord or plug, or after the appliance malfunctions, has been dropped or damaged in any manner.
- 6 Do not let the power cord hang over the edge of table or counter or touch hot surfaces such as the stove.
- 7 Extension cords are not recommended for use with this product.

- 8 Do not remove the brew basket or carafe while the appliance is brewing. **Scalding may occur if any of these parts are removed during brewing cycles.**
- 9 The use of an accessory not recommended by the manufacturer may result in fire, electric shock, create an overflow condition and scalding hazard or personal injury.
- 10 Do not operate your appliance in an appliance garage or under a wall cabinet. When storing in an appliance garage always unplug the unit from the electrical outlet. Not doing so could create a risk of fire, especially if the appliance touches the walls of the garage or the door touches the unit as it closes.

#### Operating Notice

- 11 Clogging and backing up of water and/or coffee in the filter basket can occur under any or a combination of any of the following conditions: The use of too finely ground coffee, using two or more paper filters, using the permanent filter in conjunction with a paper filter, not cleaning coffee grounds from the permanent filter, or allowing coffee grounds to spill over the filter.
- 12 Always use appliance on a dry, level surface.
- 13 Do not use this appliance for anything other than its intended use. Do not use outdoors.
- 14 Do not touch hot surfaces. Use handles or knobs.
- 15 Do not touch warming plate while the brewer is in use.

#### Glass Carafe

- 16 The carafe is designed for use with this appliance. It must never be used on a range top.
- 17 Do not set a hot carafe on a wet or cold surface.
- 18 Do not use a cracked or scratched carafe or a carafe having a loose or weakened handle.
- 19 Do not clean carafe with abrasive cleansers, steel wools pads, or other abrasive material.
- 20 Do not place carafe in microwave.

- 21 Do not expose carafe to extreme temperature changes.
- 22 Do not place on or near a hot gas or electric burner or in a heated oven.
- 23 Do not use for carbonated beverages.
- 24 Do not drink directly from the carafe! Liquid from the carafe may be very hot!
- 25 Do not use the carafe to store any other type of food when not in use.
- 26 Ensure that the carafe is completely empty before starting a cleaning or brewing cycle. Starting a cycle with water or coffee in the carafe will cause an overflow.

#### Maintenance

- 27 Remove the power cord from the electrical outlet, allow to cool before removing brew basket, water reservoir, or filters and before surface cleaning.
- 28 Clean the glass carafe with a soft brush or sponge. Do not use a wire brush.
- 29 To prevent illness from bacterial growth in the appliance, follow all cleaning instructions in the “Care & Maintenance” section of this owner’s guide.
- 30 If the product is not operating properly contact Euro-pro Europe Ltd. at 0800 862 0453 or [www.ninjacoffeebar.com](http://www.ninjacoffeebar.com) for examination, repair or adjustment.

#### Cord Statement

- 31 A short power-supply cord is provided to reduce the risks resulting from becoming entangled in or tripping over a longer cord.
- 32 If the supply cord is damaged, it must be replaced by the manufacturer, its service agent or similarly qualified persons in order to avoid hazard.

# SAVE THESE INSTRUCTIONS

This appliance complies with the WEEE-Directive 2012/19/EU on the disposal of electrical and electronic equipment (WEEE).



This marking indicates that this product should not be disposed with other household wastes throughout the EU. To prevent possible harm to the environment or human health from uncontrolled waste disposal, recycle it responsibly to promote the sustainable reuse of material sources. To return your used device, please use the return and collection systems or contact the retailer where this product was purchased. They can take this product for environmental safe recycling.

This appliance complies with the European directives for electromagnetic compatibility (EMC) 2014/30/EU and its revisions, as well as Low Voltage Directive (LVD) 2014/35/EU and its revisions.

**Guarantee:** This product is unconditionally guaranteed for one year against all defects of workmanship and materials. This guarantee does not affect your statutory rights. If this product proves unsatisfactory please contact our customer service department on freephone 0800 862 0453 or by e-mail [ukservice@euro-pro.com](mailto:ukservice@euro-pro.com).

### THIS BOOK COVERS MODEL NUMBER:

CF060UK

### TECHNICAL SPECIFICATIONS

Voltage: 220-240V , 50-60Hz.

Power: 1775 Watts

Water Reservoir

Capacity: 1.35 L

**Ninja, Ninja Coffee Bar** and **Auto-IQ** are registered trademarks of Euro-Pro Europe Ltd.

**Smooth Brew** and **Ninja Microfother** are trademarks of Euro-Pro Europe Ltd.

## Contents

Thank you for  
purchasing the  
Ninja Coffee Bar.®

Getting To Know Your Ninja Coffee Bar® .....	5
Control Panel .....	6
Features Of The Ninja Coffee Bar® .....	7
Before First Use .....	8
Setting The Clock And Delay Brew .....	9
Assembly .....	10
Preparing For Use .....	12
Filling The Water Reservoir .....	12
How Much Coffee Do You Get In Your Mug .....	12
Would You Like A Hotter Coffee .....	13
Filling The Brew Basket With Coffee .....	13
Drip Stop .....	14
Intelligent Warming Plate .....	14
Stay Warm Button .....	14
Brewing Coffee .....	15
Classic And Rich Brew .....	15
Over Ice .....	16
Cafe Forte .....	16
Con Latte Recipes .....	16
Care & Maintenance .....	17
Cleaning After A Brew .....	17
Cleaning Your Carafe .....	17
Cleaning Your Water Reservoir .....	17
How To Clean & Descale .....	17
Troubleshooting Guide .....	18
Replacement Parts .....	20

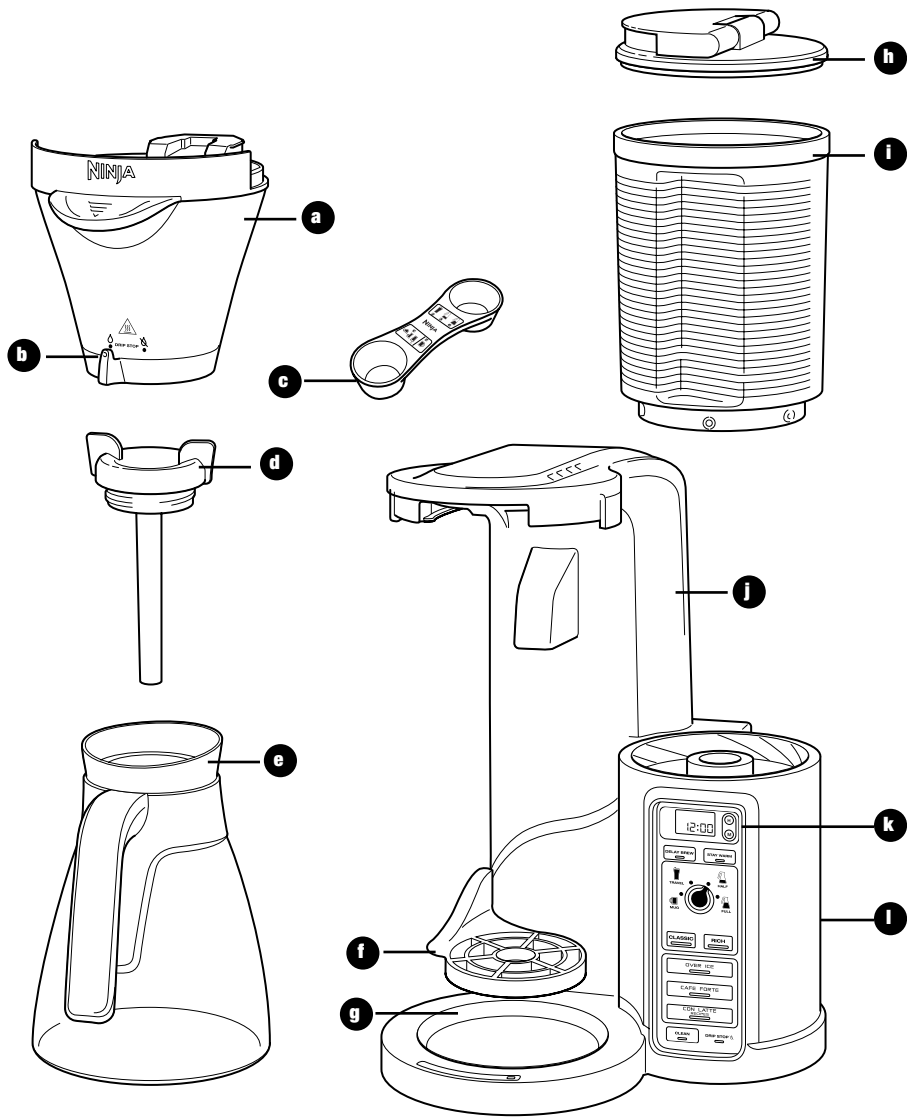

- a Removable Brew Basket
- b Drip Stop Toggle
- c Double Sided Scoop
- d Brew-Through Carafe Lid
- e Glass Carafe
- f Multi-Serve Mug Platform

- g Intelligent Warming Plate
- h Flip Top Water Reservoir Lid
- i Removable Water Reservoir
- j Brewer
- k Control Panel
- l Power Cord & Wrap (not shown)

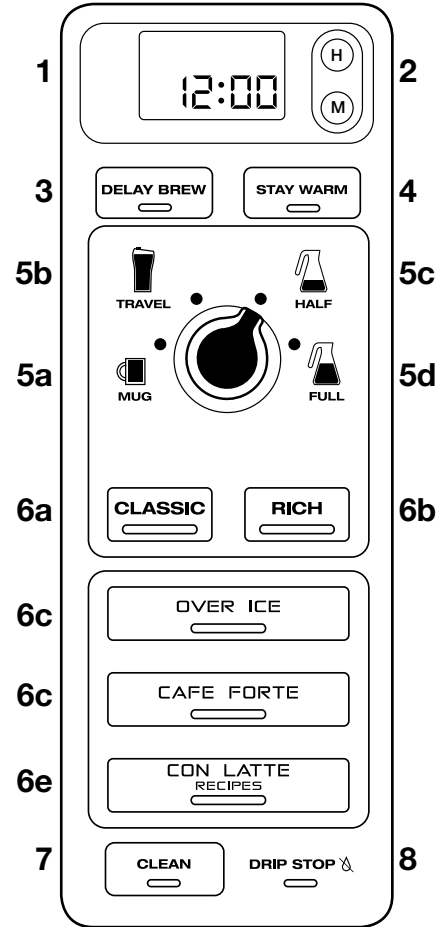

- 1 Programmable Digital Clock
- 2 Clock Hour and Minute Buttons
- 3 Delay Brew Button
- 4 Stay Warm Button
- 5 Multi-Serve Dial
  - a Mug
  - b Travel Mug
  - c Half Carafe
  - d Full Carafe
- 6 Brew Types
  - a Classic Brew Button
  - b Rich Brew Button
  - c Over Ice Button
  - d Cafe Forte Button
  - e Con Latte Recipes Button
- 7 Intelligent Clean Cycle Indicator/Button
- 8 Drip Stop Indicator

## Features of the Ninja Coffee Bar®

- **SmoothBrew™ Technology** - Does all the work for you, through temperature calibration, pre-infusion, and coffee saturation you will get a smooth, balanced, great tasting coffee everytime.
- **Multi Serve** – Ability to brew directly into your favourite mug, travel mug, or carafe.
- **Brew Options**
  - a. Classic Brew - a smooth, balanced flavour from your favourite ground coffee.
  - b. Rich Brew - a brew richer than classic with more intense flavour that really stands up to milk and sweeteners.
  - c. Over Ice Brew - surprise yourself with the satisfyingly refreshing taste of a smooth, over-ice coffee.
  - d. Cafe Forte - full of richness and aroma, a long smooth coffee that is great for drinking black or white.
  - e. Con Latte Recipes Brew - A smooth concentrated coffee that you can use to make all of your favourite, luxurious coffee shop drinks at home.
- **Multi Serve Mug Platform** – Pull it down and place your favourite mug on it and brew directly into it.
- **Removable Water Reservoir with Easy Access Flip Top Lid** – For quick and easy filling.
- **Auto-iQ®** – The Ninja Coffee Bar® knows how much water to use for each size and brew type.
- **1.35 L Glass Carafe**
- **LED Control Panel with Programmable Digital Clock**
- **24-HR Programmable Delay Brew Button** – Set it to automatically brew the following morning.
- **Drip Stop** – Stops the flow of coffee from the brew basket allowing you to pour a mug mid-brew; switch toggle to the closed position to prevent dripping once the brew cycle is finished.
- **Clean Function** – It illuminates when your Ninja Coffee Bar® senses that there is hard water calcium build up in your brewer which can affect the flavour of your coffee. When it illuminates, follow the cleaning instructions in the Care & Maintenance section or printed on the back of your brewer.
- **Stay Warm Button** – Your warming plate will automatically turn on after brewing a carafe and remain on for 30 minutes. The Stay Warm button allows you to manually turn the warming plate off.
- **Intelligent Warming Plate** – Automatically adjusts the temperature of the warming plate to keep your coffee at the ideal drinking temperature without burning it.
- **Sleep Mode** – 30 minutes after brewing the Ninja Coffee Bar will enter sleep mode to conserve energy.
- **Audible Ready Signal** – Alerts you that your coffee is ready.
- **Auto shut off** – Automatically turns off the warming plate 30 minutes after you brew coffee.

### Multi Serve

Brew into a mug, travel mug, or classic carafe or half carafe.

Mug

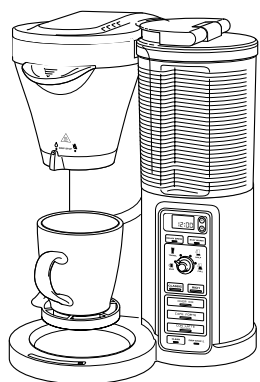

Travel Mug

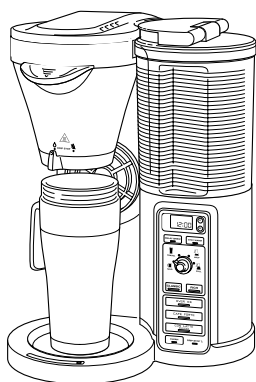

Classic Carafe or Half Carafe

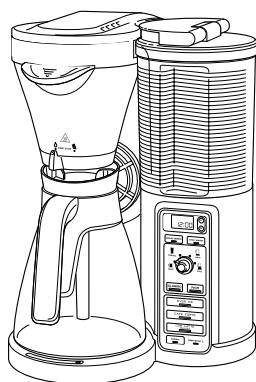

## Before First Use

### PLEASE KEEP THESE IMPORTANT SAFEGUARDS IN MIND WHEN USING THE APPLIANCE:

- ⚠ **CAUTION: APPLIANCE CREATES HOT LIQUID. HANDLE WITH CARE.**
- ⚠ **CAUTION: DO NOT remove the vessel while the appliance is running without the Drip Stop in the closed position. Return the vessel quickly and open the Drip Stop to continue the brew.**
- ⚠ **CAUTION: Never open the brew basket when the coffeemaker is in use.**
- ⚠ **CAUTION: Please ensure that you are using at least a 350 ml mug for the mug size and a 470 ml travel mug for the travel mug size to prevent overflow and a scalding injury.**

**IMPORTANT: DO NOT run the appliance without water.**

**IMPORTANT: Always place a vessel beneath the brew basket to receive the brewed coffee.**

**IMPORTANT: DO NOT overfill the water reservoir, fill water only to the Max Fill line.**

- 1 Remove all packaging material, stickers and labels from the brewer.

**NOTE:** The glass carafe is dishwasher safe. Place on top rack only.

- 2 Wash the water reservoir, glass carafe and brew basket in warm, soapy water with a soft cloth.
- 3 Rinse and dry thoroughly.
- 4 Wipe the intelligent warming plate with a damp cloth.
- 5 Before first use, run two full carafe cycles with water only and discard water.

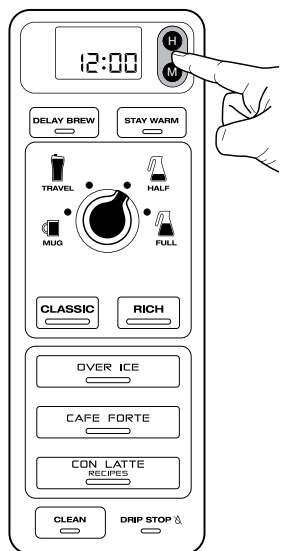

Fig. 1

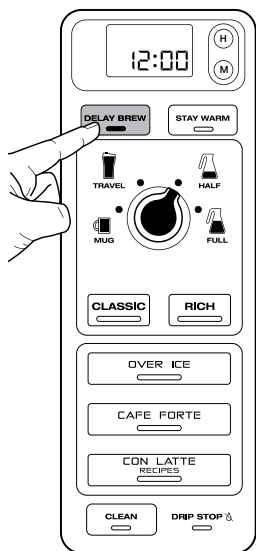

Fig. 2



Fig. 3

**TO SET THE CLOCK**

- 1 Plug the power cord into an electrical outlet. The clock will flash on the control panel to indicate that the time has not been set.
- 2 Press the H (hour) or M (minute) button until you reach the current time. **(Fig. 1)**
- 3 After 5 seconds the clock will stop flashing and the clock will be set.  
**NOTE:** If the clock stops flashing and does not display the correct time of day, pressing the H (hour) or the M (minute) button at any time will cause the clock to flash again. You can now re-program the correct time of day by following the steps above.

**NOTE:** If you unplug the brewer or in the event of an extended power loss, you will need to reset the clock the next time the brewer is plugged in.

**TO SET THE DELAY BREW TIME**

- 1 Press Delay Brew. The Delay Brew button will illuminate and the clock will begin to flash "00:00" or the last delay brew time that was set. **(Fig. 2)**
- 2 While the clock is flashing, press the H (hour) or M (minute) button to set the time that you would like the delay brew to begin.
- 3 Once the proper time has been set, select the size of the vessel that you would like to brew.
- 4 Select the Brew Type that you desire from the flashing buttons. The selected brew type will be lit. **(Fig. 3)**

- 5 Once the time, brew size, and brew type have been set, allow the Delay Brew to flash and lock in or press the Delay Brew button to activate the Delay Brew. When the Delay Brew is activated, the light on the Delay Brew button will illuminate and an audible signal will play to verify the Delay Brew is set.

- 6 The Delay Brew time is now set and your Ninja Coffee Bar® will automatically brew at the time you programmed.

**NOTE:** To deactivate the Delay Brew cycle, press the Delay Brew button once more and the light on the Delay Brew button will turn off. Any change to the selected brew size or starting any other brew will cancel the programmed Delay Brew.

- 7 Place the appropriate-sized vessel under brew basket for the selected size.

**IMPORTANT:** Make sure the Drip Stop is in the open position.

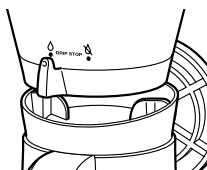

Go to [www.ninjacoffee.eu](http://www.ninjacoffee.eu) for more information and how-to videos.

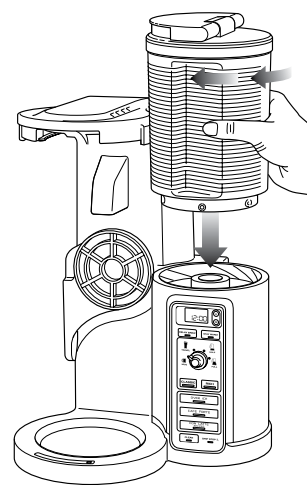

Fig. 4

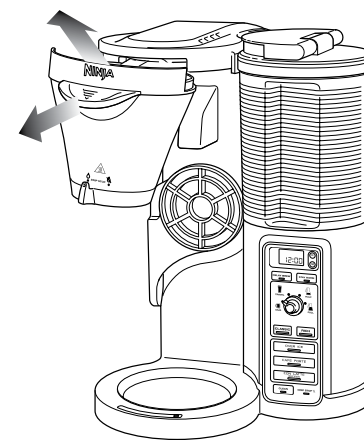

Fig. 5

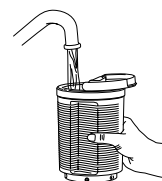

Fig. 4a

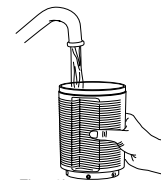

Fig. 4b

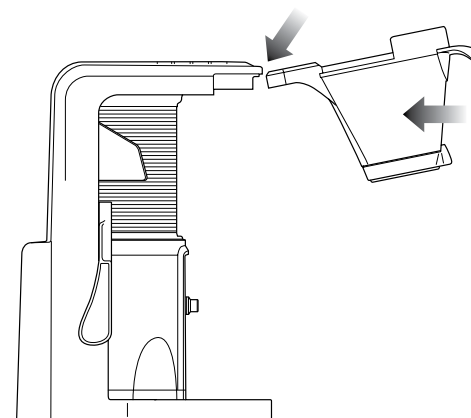

Fig. 6

- 1 Place the brewer on a dry, clean and level surface.
- 2 Holding the water reservoir by the grip, twist anticlockwise to remove. **(Fig. 4)** Either flip the lid top over **(Fig. 4a)** or remove lid by twisting anticlockwise to remove **(Fig. 4b)**. Fill with water up to, but not exceeding the Max Fill Line (1.35 L). To replace the water reservoir, place on top of the base and twist clockwise until a click indicates it is locked in place.

- 3 Pull the brew basket out and angle up slightly to remove it from the brewer. **(Fig. 5)** To reinsert, align the brew basket with the rails and slide back into the brewer. **(Fig. 6)**
- 4 Once the brew basket is in place, push all the way into place until you hear a slight click.

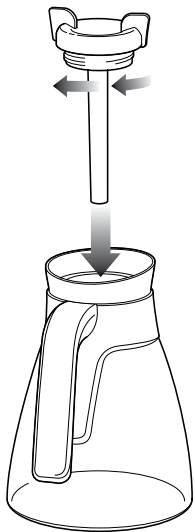

Fig. 7

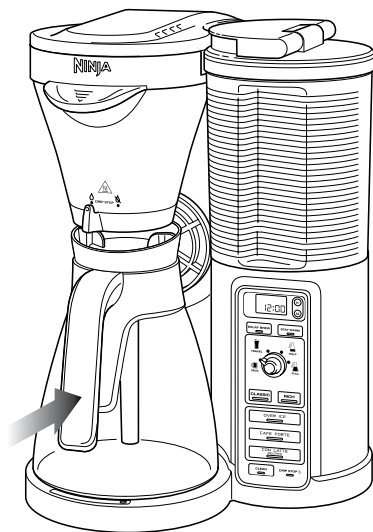

Fig. 8

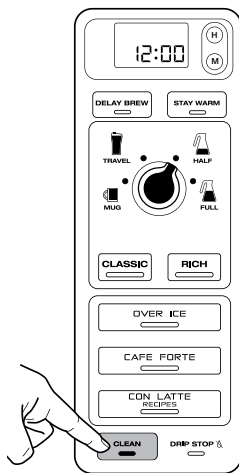

Fig. 9

- 5 Twist the brew-through lid clockwise onto the glass carafe to lock into place. **(Fig.7)**
- 6 Center the carafe below the brew basket. **(Fig. 8)**  
**NOTE:** Do not use any coffee for the first two brew cycles in order to clean the brewer.
- 7 Plug the brewer into an electrical outlet.

- 8 Once all parts are securely in place, press the Clean button to thoroughly clean the machine before first use. **(Fig. 9)**
- 9 Once the clean cycle has completed discard the water in the carafe and repeat, beginning with step 2, with one more clean cycle of water before first use.

## Preparing for Use

**⚠ CAUTION:** Only fill water reservoir up to, but not exceeding the Max Fill line with water; we recommend fresh, cool, filtered water. Do not fill water reservoir with any other liquids such as brewed coffee, carbonated beverages, etc. as other liquids may damage your brewer.

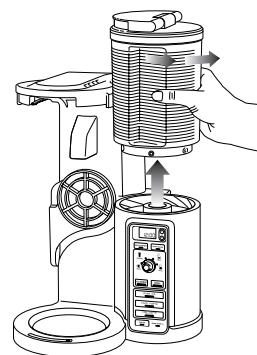

Fig. 10



Fig. 11a

OR

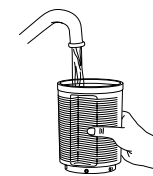

Fig. 11b

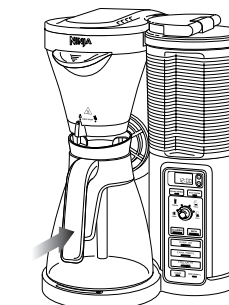

Fig. 12

### FILLING THE WATER RESERVOIR

- 1 For easy filling, remove the water reservoir by slightly twisting anticlockwise until it is free from the brewer. **(Fig. 10)**
- 2 Either flip the lid top over or remove lid by twisting anticlockwise to remove. **(Fig. 11a, Fig. 11b)**  
**NOTE:** The water reservoir and water reservoir lid can lock in multiple locations.
- 3 For best results, fill the water reservoir with fresh, cool, filtered water. Ensure that the water is above the minimum fill line for the brew size that is selected. Do not exceed the Max Fill line. The machine's intelligence will automatically measure the amount of water needed. To avoid refilling after each mug, fill to the Max Fill Line.

**NOTE:** Do not fill past the Max Fill Line as water may overflow onto the brewer and worktop.

**Depending on the size and brew type, you may have water left in the reservoir.**

- 4 Place the water reservoir back on the brewer and twist clockwise until you feel the reservoir lock into place.
- 5 Place the vessel that you would like to brew into underneath the brew basket-ensure that the vessel is centered under the brew basket. **(Fig. 12)**

**NOTE:** After removing the water reservoir, there may be a small amount of water in the reservoir valve. This can be easily removed with a dry cloth.

### HOW MUCH COFFEE DO YOU GET IN YOUR MUG?

Each size and brew type produces a different amount of coffee to optimise strength, taste, and size.

**NOTE:** The coffee grounds will absorb some of the water that is brewed, resulting in slightly less brewed coffee than water used.

**⚠ CAUTION:** Please ensure that you are using at least a 350 ml mug for the mug size and a 470 ml travel mug for the travel mug size.

#### Approximate Brew Volume





Size / Brew	Mug	Travel Mug	Half Carafe	Full Carafe
Classic	250 ml	379 ml	577 ml	1.1 L
Rich	226 ml	329 ml	521 ml	1.0 L

Brew / Size	Over Ice	Cafe Forte	Con Latte
Mug	157 ml	251 ml	80 ml

## Preparing for Use - cont.

### WOULD YOU LIKE A HOTTER COFFEE?

Have you ever wondered why you get paper mugs on the go? The type of mug you brew into can drastically influence the drinking temperature!

MUG TYPE	CERAMIC MUG			NINJA® MUG	PAPER MUG
<b>Mug Temperature</b>	Room Temp	Pre-warmed with hot water	Pre-warmed in microwave with milk	Room Temp	Room Temp
<b>Drinking Temperature</b>	Hot 	Hotter 	Hotter 	Hotter 	Hottest 
<b>Why is there a difference?</b>	A cold ceramic mug will steal heat from the coffee as it warms itself up.	If the mug is already warm, it will not steal as much heat from the coffee.	Just like your cold mug, cold milk lowers the temperature of your coffee.	The Ninja® double wall mug is designed to retain initial coffee temp better than a ceramic mug.	Unlike a ceramic mug, a thinner paper mug does not steal as much heat from the coffee.

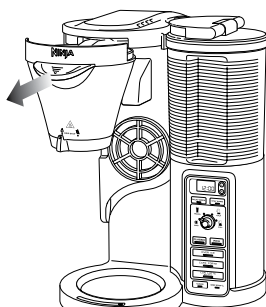

Fig. 13

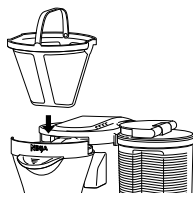

Fig. 14

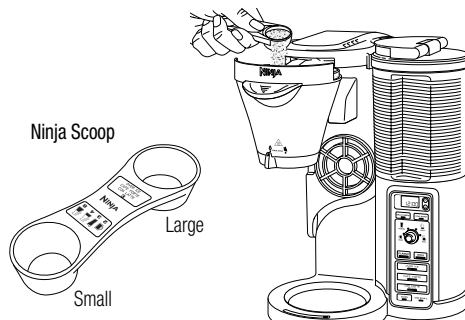

Fig. 15a

### FILLING THE BREW BASKET WITH COFFEE

For best results, use the below measurements of ground coffee for each size brew.

**CAUTION:** The maximum capacity for ground coffee is 8 Small Ninja Scoops. Exceeding this amount or using fine ground coffee may cause overflow.

- 1 Open the brew basket by sliding the brew basket out of the brewer. (Fig. 13)

**NOTE:** The brew basket can be removed from the brewer by lifting the brew basket at a slight upward angle.

**NOTE:** Check for any loose grounds that may be left in the brew basket. Remove and rinse brew basket if needed.

- 2 Insert the Ninja Premium Gold Tone Filter or a No. 4 Paper filter, into the brew basket making sure that it is fully seated. (Fig. 14)

- 3 Use the Ninja Scoop (Fig. 15a) and follow the measurements below to fill the filter. These measurements are based on level scoops.

Small Scoop	Ninja® Scoop
Mug	2 scoops
Travel Mug	3 scoops
Half Carafe	4 scoops
Full Carafe	8 scoops
Large Scoop	Ninja® Scoop
Over Ice	3 scoops
Cafe Forte	3 scoops
Con Latte	3 scoops

**Note:** Exceeding the recommended medium grind size for whole beans and recommended ninja Scoops may cause the brew basket to overflow.

- 4 Slide the brew basket back into the brewer and click in place.

**CAUTION:** HOT WATER Do not remove the brew basket or vessel while brewing.

**CAUTION:** STEAM Do not touch steam vents or the top of the brewer while brewing.

**CAUTION:** The brew basket is hot after brewing. Always allow the brewer to cool down before cleaning.

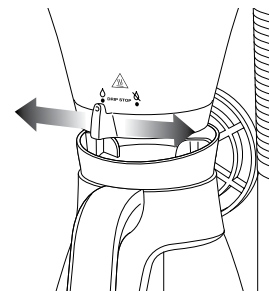

Fig. 16

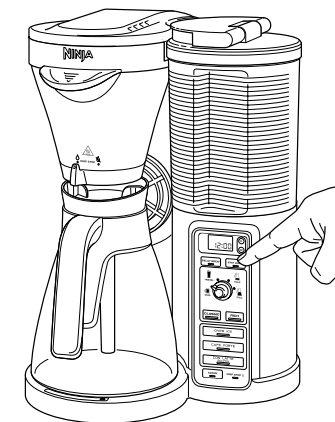

Fig. 17

### DRIP STOP

**NOTE:** If the Drip Stop is closed before you begin a brew, the brewer will notify you with 5 beeps. Set the Drip Stop to the open position and select your brew.

### CAN'T WAIT FOR THAT FIRST MUG TO BE READY?

- 1 When brewing a carafe, close the Drip Stop to pause the brew cycle and pour a mug. Remember to reopen the Drip Stop to complete the brew. (Fig. 16)

**NOTE:** If you forget to open the Drip Stop, the Ninja Coffee Bar® will pause the brew, and after 20 seconds it will give you a friendly audible reminder. After 6 minutes the brew will be canceled.

### CAN'T WAIT FOR THE LAST FEW DROPS?

When the brew cycle is complete, set the Drip Stop to the closed position to stop dripping from the brew basket.

**NOTE:** While the Drip Stop is closed the Drip Stop indicator will light up in the bottom right hand corner of the control panel.

**NOTE:** Remember to open the Drip Stop when you're ready to brew again. If you forget, your Ninja Coffee Bar® will give you a friendly audible reminder.

### INTELLIGENT WARMING PLATE

The intelligent warming plate will automatically turn on when brewing a half or full carafe. The Intelligent Warming Plate will adjust the heat it produces in order to avoid burning the coffee over time.

**CAUTION:** The HOT SURFACE light will illuminate when the warming plate is hot. Do not touch the surface when this light is illuminated.

### STAY WARM BUTTON

Press the Stay Warm Button after the brew to turn the Intelligent Warming Plate off. You can turn the Intelligent Warming Plate back on within 30 minutes of the brew by pressing the stay warm button again if desired. (Fig. 17)



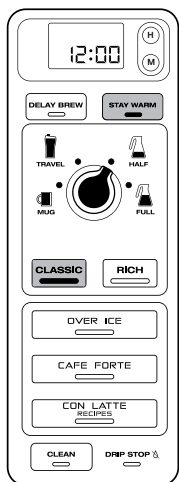

Fig. 18

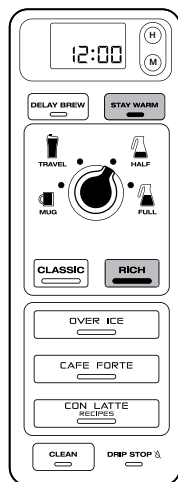

Fig. 19

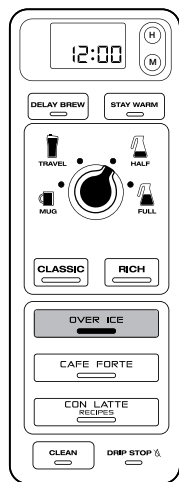

Fig. 20a

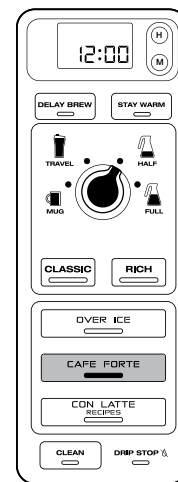

Fig. 20b

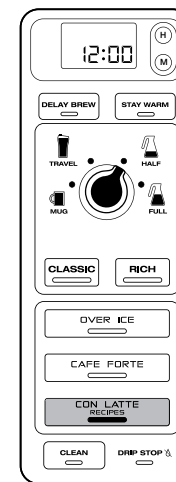

Fig. 20c

## BREWING COFFEE

**NOTE:** Each brew has a pre-infusion cycle with varying times. The brew will begin, stop, and be quiet for a short period of time before it begins again. This process is used to evenly saturate your coffee grounds.

**NOTE:** For a hotter coffee, rinse the coffee mug or glass carafe with hot water prior to brewing.

**CAUTION:** Ensure the carafe is completely empty before starting a brewing cycle. Starting a brewing cycle with coffee in the carafe will cause an overflow.

### CLASSIC OR RICH BREW

**Classic Brew** - A smooth, balanced flavour.

**Rich Brew** - Richer than classic with more intense flavour.

- 1 After filling the water reservoir and adding ground coffee to the filter, be sure that the Drip Stop is open and the reservoir, basket, and filter are securely in place.
- 2 Use the multi-serve dial to select the size of coffee you would like to brew. Place the empty vessel that you would like to brew into underneath the brew basket.

**NOTE:** If making a single mug, lower the multi-serve mug platform down and center the mug on the mug platform. Please ensure that you are using at least a 350 ml mug for the mug size and a 470 ml travel mug for the travel mug size.

- 3 Press the Classic Brew or the Rich Brew button and the brew will begin. (Fig. 18, Fig. 19) Press the Classic or Rich button again to cancel the brew.

**NOTE:** If brewing a half carafe or a full carafe, the Stay Warm indicator and Intelligent Warming Plate will automatically turn on. (Fig. 18, Fig. 19) This can be turned off by pressing the Stay Warm button once illuminated. The Intelligent Warming Plate will turn off automatically after 30 minutes.

**NOTE:** Do not remove water reservoir, brew basket, or vessel while brewing.

- 4 The Ninja Coffee Bar® will beep to signal a completed brew.

**NOTE:** Rich Brew will use slightly less water and yield slightly less brewed coffee than Classic Brew.

Go to [www.ninjacoffeebar.com](http://www.ninjacoffeebar.com) for more information and how-to videos.

### OVER ICE BREW

Surprise yourself with the satisfyingly refreshing taste of a smooth, over-ice coffee.

**CAUTION:** DO NOT USE GLASSWARE.

- 1 After filling the water reservoir, add ground coffee to the filter, be sure that the Drip Stop is open, reservoir, basket, and filter are securely in place.
- 2 Set the multi-serve dial to the Mug Setting.
- 3 Before Brewing, fill your mug to the top with ice cubes and place the vessel below the brew basket. Press “Over Ice” and the brew will begin. (Fig. 20a) Press the Over Ice button again to cancel the brew.

**IMPORTANT:** Always fill the desired vessel to the top with ice before placing it below the brew basket. Do not add ice to the water reservoir.

- 4 The Ninja Coffee Bar® will beep to signal a completed brew.

### APPROXIMATE BREW VOLUME

**CAUTION:** Make sure to use the proper mug size, not doing so may lead to coffee overflowing the mug.

OVER ICE		
Mug Size:	Coffee Only	With Ice
Mug	157 ml	330 ml

### CAFE FORTE

Full of richness and aroma, a long smooth coffee that is great for drinking black or white.

**CAUTION:** DO NOT USE GLASSWARE.

- 1 After filling the water reservoir, add ground coffee to the filter, be sure that the Drip Stop is open, reservoir, basket, and filter are securely in place.
- 2 Set the multi-serve dial to the Mug Setting.
- 3 Press “Cafe Forte” and the brew will begin. Press the Cafe Forte button again to cancel the brew.
- 4 The Ninja Coffee Bar® will beep to signal a completed brew.

### CON LATTE RECIPES

A smooth concentrated coffee that you can use to make all of your favourite, luxurious coffee shop drinks at home.

**CAUTION:** DO NOT USE GLASSWARE.

- 1 After filling the water reservoir, add ground coffee to the filter, be sure that the Drip Stop is open, reservoir, basket, and filter are securely in place.
- 2 Set the multi-serve dial to the Mug Setting.
- 3 Press “Con Latte Recipes” and the brew will begin. Press the Con Latte Recipes button again to cancel the brew.
- 4 The Ninja Coffee Bar® will beep to signal a completed brew.

## Care & Maintenance

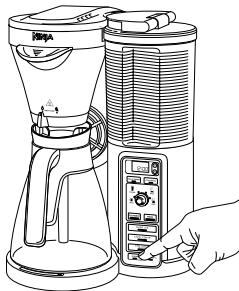

Fig. 21

### CLEANING AFTER A BREW

**CAUTION:** Make sure that the brewer is unplugged from the power source before cleaning.

**CAUTION:** Be sure to allow the brewer to cool before cleaning.

**IMPORTANT:** Discontinue use if the glass carafe is scratched or handle is loose or damaged.

**NOTE:** Do not leave coffee in the glass carafe for an extended period of time after a brew.

**NOTE:** Do not leave water in the reservoir unused for multiple days. Rinse and replace with fresh water.

- 1 Before cleaning, close the Drip Stop.
- 2 After each brew is complete and the coffee grounds have cooled, carefully remove the brew basket from the brewer, discard the coffee grounds, rinse and wash with warm soap and water.

**NOTE:** The brew basket is not dishwasher safe.

**NOTE:** The flip top water reservoir lid is not dishwasher safe

**NOTE:** If coffee grounds spilled over into the brew basket or in the overflow channels, remove and rinse under water until grounds are removed.

- 3 Wash the carafe and brew-through lid with soap and warm water. Use a bottle brush or a cloth to wash the inside of the carafe.

**NOTE:** The brew-through lid, glass carafe and water reservoir are top shelf dishwasher safe.

**IMPORTANT:** Clean the glass carafe with a soft brush or sponge. Do not use a wire brush.

- 4 Wipe machine down with a warm cloth with soap and water. Let the warming plate cool before cleaning with a wet cloth and soap and water. **Do not immerse the base in water.**

**NOTE:** For best results, use a bottle brush. This will allow you to scrub all of the inside with soap and hot water.

### CLEANING YOUR CARAFE

We recommend rinsing your carafe with warm soapy water, or placing in the top shelf of your dishwasher. If you want to clean the carafe more thoroughly, we recommend using a soft foam brush such as the one shown.



## CLEANING YOUR WATER RESERVOIR

- 1 Empty the water reservoir.
- 2 Hand wash with dish soap and rinse or place on the top rack of your dishwasher.

### HOW TO CLEAN & DESCALE THE BREWING SYSTEM

**CAUTION:** Be sure to allow the brewer to cool before cleaning.

**CAUTION:** DO NOT immerse the coffeemaker into water or any other liquid.

**NOTE:** Cleaning and descaling shall be performed on a weekly basis. Cleaning your Ninja Coffee Bar® is recommended to keep your brewer brewing hot, rich, and smooth coffee.

The Clean button will illuminate when your Ninja Coffee Bar® senses there is a calcium build up on your machine, that could be affecting the flavour of your coffee. To clean your machine and keep the same great taste of Ninja® coffee, follow the directions below.

- 1 Select the carafe size and set the carafe in place beneath the brew basket.
- 2 Use a descaling solution and follow the directions on the package and fill up to, but not exceeding the Max Fill line (1.35 L).

OR

Fill the water reservoir to the mug line (325 ml) with white vinegar, then fill the rest of the water reservoir with water up to, but not exceeding the Max Fill line (1.35 L).

**IMPORTANT:** Use only white vinegar.

- 3 Once the water reservoir is filled with your cleaning solution and water mixture (**not exceeding the Max Fill line**), simply press the Clean button to activate the clean cycle. (Fig. 21)

**NOTE:** The clean cycle takes approximately 8 minutes to fully descale and clean the machine.

- 4 Once the clean cycle is complete, empty and rinse the carafe and water reservoir. Please take special care to thoroughly clean the carafe and water reservoir to remove any cleaning solution that could affect the flavour of your coffee.

- 5 Once the clean light turns off, fill with fresh water up to, but not exceeding the carafe line (1.35 L Max Fill line) and run 2 or 3 clean cycles with fresh water to rinse. Discard the water in the carafe after each cycle.

**NOTE:** If the Clean light illuminates on the next brew after a clean cycle, this means there is still calcium build up on the brewer. Repeat steps above and the clean light will automatically shut off when it senses your Ninja Coffee Bar® is clean and free of calcium build up!

Please call customer service if any servicing needs to be performed on the brewer at 0800 862 0453.



If you continue to use your Ninja Coffee Bar® after the Clean light has illuminated it will continue to remain illuminated and over time it will alert you to clean and descale your unit through a series of beeps.

## Troubleshooting Guide

PROBLEMS	POSSIBLE REASONS & SOLUTIONS
<b>Sediment in my coffee.</b>	If there is sediment at the bottom of the brewed coffee, this may be due to finely ground coffee in a permanent filter. To reduce the amount of sediment in the brewed coffee use a slightly coarser grind or use a paper filter.
<b>Grounds in my coffee.</b>	If there are grounds in your coffee, check to make sure the brew basket did not overflow. If there are too many grounds in the brew basket, or you are using a fine ground coffee, the grounds will flow into an overflow channel designed to make sure overflow is captured in the brew vessel. For best results use medium ground coffee in the recommended measurements.
<b>Brew Basket dripping after brew.</b>	Check to see if the Drip Stop toggle is set to the closed, no drip position. If the Drip Stop is set to the closed, no drip position and the brewer continues to drip, run a clean cycle or wash the brew basket thoroughly with warm, soapy water.
<b>Coffee is not hot enough.</b>	To keep your coffee hotter longer, preheat your mug or carafe by rinsing it with hot water from the tap. If using a microwave safe mug with milk, try preheating the milk in the microwave for 30 seconds. <b>NOTE:</b> Never place carafe in the microwave.
<b>Over Ice Brew is not cold.</b>	The Over Ice Brew is designed to brew hot coffee over ice to lock in the flavour for rich, smooth iced coffee. Make sure your mug, travel mug, or carafe is filled all the way to the top with ice cubes.
<b>Weak coffee.</b>	If the coffee tastes weak, try adding more coffee grounds into the brew basket for the next brew cycle. If the coffee is still weak after adding more coffee grounds, try Rich Brew to make a stronger more concentrated mug.
<b>Coffee too strong.</b>	Try using a more coarse grind. If the coffee is still too strong, try using less coffee grounds.
<b>Brew will not start.</b>	Check to make sure the brewer is plugged in and water is in the water reservoir. If the drip stop is in the open position, check that the brew basket is pushed all the way into the brewer. If you hear 5 beeps, check that the drip stop is in the open position. <b>NOTE:</b> The brew will begin, stop, and be quiet for a short period of time before it begins again. This process is used to evenly saturate your coffee grounds.
<b>Brew cycle is too slow.</b>	A carafe brew will take approximately 8 minutes and the single mug will take approximately 4 minutes. If the brew cycle is taking longer than normal, run the clean cycle with the descaling solution.

## Troubleshooting Guide - cont.

PROBLEMS	POSSIBLE REASONS & SOLUTIONS
<b>My mug, travel mug or carafe overflowed.</b>	<p>The mug, travel mug or carafe may not have been empty prior to brewing.</p> <p>The water exceeded the Max Fill line on the water reservoir prior to brewing.</p> <p>Please ensure that you are using at least a 350 ml mug for the mug size and a 470 ml travel mug for the travel mug size.</p>
<b>Brew basket overflowed.</b>	<p>Check the amount of coffee or type of grind used.</p>
<b>Water left in my reservoir.</b>	<p>Ninja Coffee Bar® allows you to fill the reservoir up to but not exceeding the Max Fill line and Auto-iQ® One Touch Intelligence will only use the water needed for the brew size and style selected.</p> <p>After a brew you may notice left over water in your water reservoir after filling to the minimum fill line of the size selected. The water reservoir markings are minimum fill lines that indicate if there is enough water for the proper brew size in the reservoir for any brew style in that size, but all brew styles use different amounts of water to create the proper flavour and concentration.</p> <p>You can brew multiple mugs before needing to refill.</p>
<b>Does it take coffee pods?</b>	<p>This brewer is designed to brew coffee grounds only. Do not insert pods or capsules.</p>
<b>My Ninja Coffee Bar® is leaking.</b>	<p>If the leak is coming from the brew basket, be sure all the parts are fit securely in the brewer.</p> <p>If the leak is coming from the bottom of the brewer call customer service at 0800 862 0453.</p>
<b>My Ninja Coffee Bar® beeped and did not complete the full brew that I selected.</b>	<p>Ensure the water reservoir is locked in place and is filled with enough water for the desired brew.</p> <p>Check the CLEAN indicator light. If illuminated, run a clean cycle with the appropriate descaling solution or a white vinegar mixture. See Care &amp; Maintenance section.</p> <p>Check the Drip Stop indicator light. If illuminated, ensure the brew basket is fully inserted into the brewer and open the Drip Stop once the vessel is placed under the brew basket.</p> <p>If the problem persists please call customer service at 0800 862 0453.</p>

PROBLEMS	POSSIBLE REASONS & SOLUTIONS
<b>I noticed the carafe design &amp; lid. What are the benefits?</b>	<p>Our unique carafe shape and design has the following benefits:</p> <ul style="list-style-type: none"> <li>Easy grip design making it easy to pour coffee without dripping.</li> <li>Thoroughly mix your coffee from the first drop to the last thanks to the Brew-Through Carafe Lid.</li> <li>Optimise coffee temperature.</li> <li>Allow you to brew both hot and iced coffee.</li> </ul>
<b>Coffee Brew Volume: What impacts coffee brew volume?</b>	<p>When you make hot coffee, coffee grounds will absorb some of the water that is brewed resulting in slightly less brewed coffee than the water used. The more coffee you use, the more water will be absorbed. Additionally, our wider bottom carafe holds most of the volume coffee at the base which helps control the temperature more evenly.</p> <div style="display: flex; justify-content: space-around; align-items: center;"> <div style="text-align: center;">  <p>Classic Brew:</p> <p><b>Full Carafe</b></p> </div> <div style="text-align: center;">  <p><b>Half Carafe</b></p> </div> </div>
<b>How does the Ninja coffee bar keep coffee at the right temperature?</b>	<p>The carafe is designed to keep most of the coffee volume in the bottom so it can be held closer to the Precise Temp Warming plate. This helps maintain the coffee at the ideal drinking temperature.</p>

Go to [www.ninjacoffee.eu](http://www.ninjacoffee.eu) for more information and how-to videos.

## Replacement Parts

### ORDERING REPLACEMENT PARTS

To order additional parts and attachments, please visit our website: [www.ninjacoffee.eu](http://www.ninjacoffee.eu) or feel free to contact customer service: **0800 862 0453**





**Euro-Pro Europe Ltd.**

Century Way, Thorpe Park, Leeds, LS15 8ZB, UK

0800 862 0453

[www.ninjacoffee.eu](http://www.ninjacoffee.eu)

Copyright © 2016 Euro-Pro Europe Ltd.

**Ninja**, **Ninja Coffee Bar** and **Auto-IQ** are registered trademarks of Euro-Pro Europe Ltd.  
**Smooth Brew** and **Ninja Microfother** are trademarks of Euro-Pro Europe Ltd.

Printed in China

Illustrations may differ from actual product. We are constantly striving to improve our products, therefore the specifications contained herein are subject to change without notice.

CF060UK\_69\_IB\_250220\_New address

